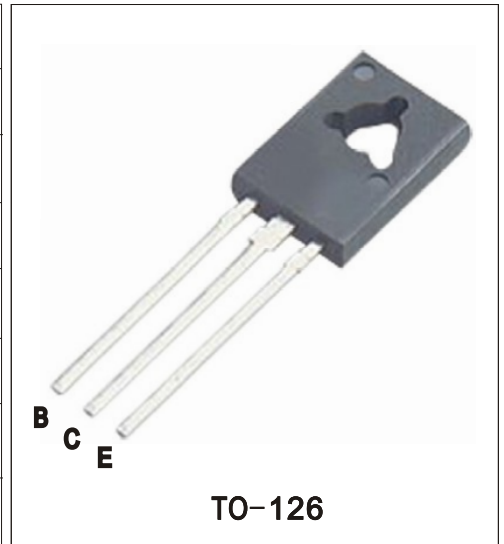

**220V系列晶体管 / (220V SERIES TRANSISTORS)**
**HLD133DA**

- 特点：耐压高 开关速度快 安全工作区宽 符合ROHS指令
- FEATURES: ■HIGH VOLTAGE CAPABILITY ■HIGH SPEED SWITCHING ■WIDE SOA ■ROHS COMPLIA
- 应用：节能灯 电子镇流器 电子变压器
- APPLICATION: ■FLUORESCENT LAMP ■ELECTRONIC BALLAST ■ELECTRONIC TRANSFORMER

**● 最大额定值：( Tc=25°C )**
**● Absolute Maximum Ratings ( Tc=25°C )**
**TO-126**

参数 PARAMETER	符号 SYMBOL	额定值 VALUE	单位 UNIT
集电极-基极电压 Collector-Base Voltage	V <sub>CB0</sub>	700	V
集电极-发射极电压 Collector-Emitter Voltage	V <sub>CEO</sub>	400	V
发射极-基极电压 Emitter-Base Voltage	V <sub>EBO</sub>	9	V
集电极电流 Collector Current	I <sub>C</sub>	3.5	A
集电极耗散功率 Total Power Dissipation	P <sub>C</sub>	40	W
最高工作温度 Junction Temperature	T <sub>J</sub>	150	°C
贮存温度 Storage Temperature	T <sub>STG</sub>	-55-150	°C

**● 电特性：( Tc=25°C )**
**● Electronic Characteristics ( Tc=25°C )**

参数 PARAMETER	符号 SYMBOL	测试条件 TEST CONDITION	最小值 MIN	最大值 MAX	单位 UNIT
集电极-基极截止电流 Collector-Base Cutoff Current	I <sub>CB0</sub>	V <sub>CB</sub> =700V		100	μA
集电极-发射极截止电流 Collector-Emitter Cutoff Current	I <sub>CEO</sub>	V <sub>CE</sub> =400V, I <sub>B</sub> =0		250	μA
集电极-发射极电压 Collector-Emitter Voltage	V <sub>CEO</sub>	I <sub>C</sub> =10mA, I <sub>B</sub> =0	400		V
发射极-基极电压 Emitter-Base Voltage	V <sub>EBO</sub>	I <sub>E</sub> =1mA, I <sub>C</sub> =0	9		V
集电极-发射极饱和电压 Collector-Emitter Saturation Voltage	V <sub>cesat</sub>	I <sub>C</sub> =0.5A, I <sub>B</sub> =0.1A		0.35	V
		I <sub>C</sub> =1.0A, I <sub>B</sub> =0.25A		0.60	
		I <sub>C</sub> =3.0A, I <sub>B</sub> =1.0A		1.50	
发射极-基极饱和电压 Emitter-Base Saturation Voltage	V <sub>besat</sub>	I <sub>C</sub> =1.0A, I <sub>B</sub> =0.2A		1.0	V
电流放大倍数 DC Current Gain	h <sub>FE</sub>	V <sub>CE</sub> =5V, I <sub>C</sub> =1mA	8		
		V <sub>CE</sub> =5V, I <sub>C</sub> =0.5A	10	40	
		V <sub>CE</sub> =5V, I <sub>C</sub> =2.0A	5		
贮存时间 Storage Time	T <sub>s</sub>	V <sub>CC</sub> =5V I <sub>C</sub> =0.25A (Ui9600)	2.0	4.0	μS
下降时间 Falling Time	T <sub>f</sub>			0.8	
内置二极管正向压降 Diode Forward Voltage	V <sub>f</sub>	I <sub>F</sub> =2.0A		2.0	V

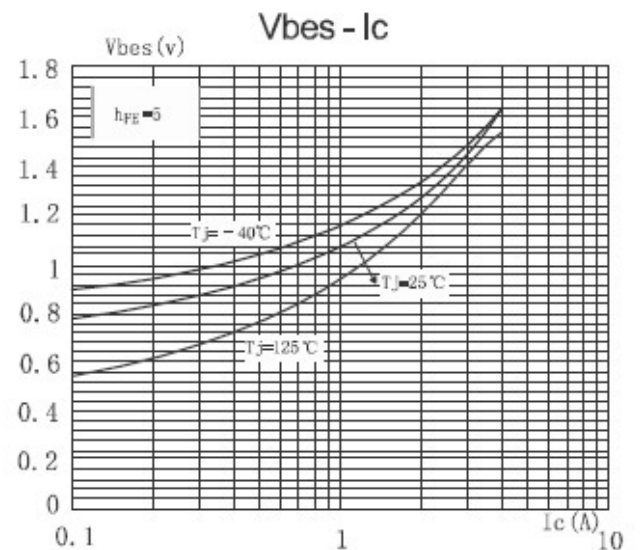
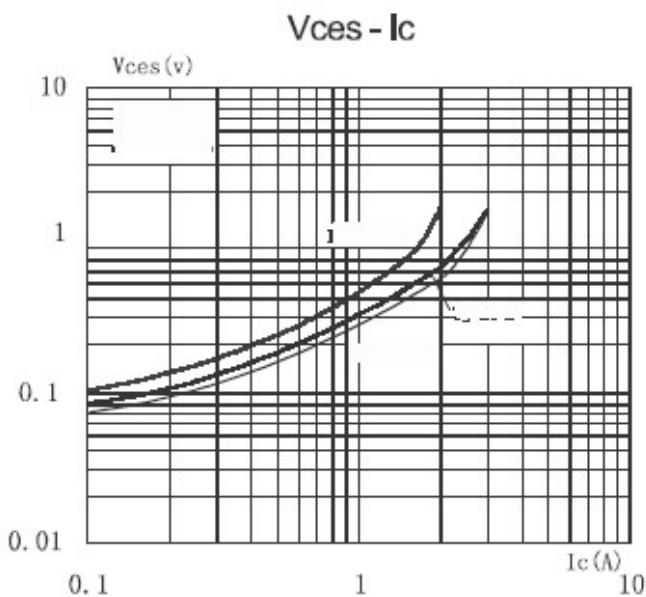
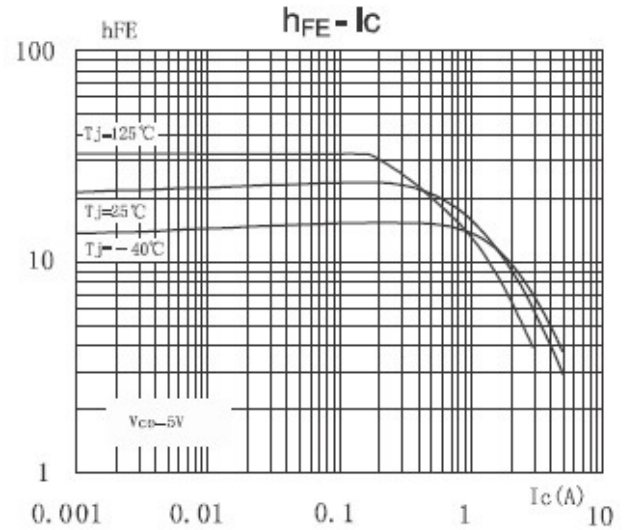
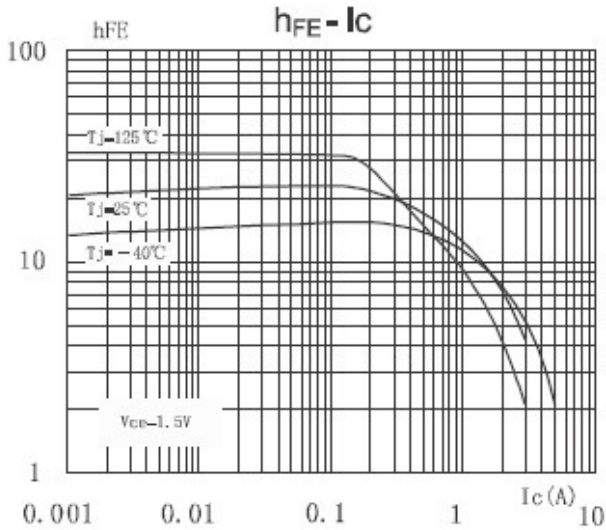
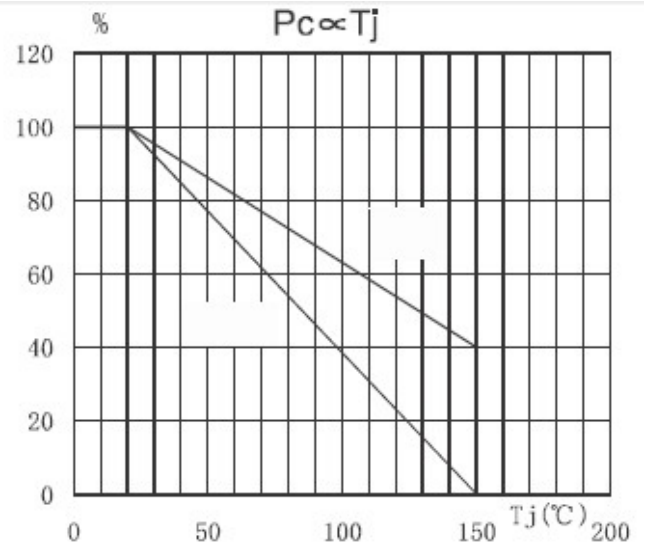
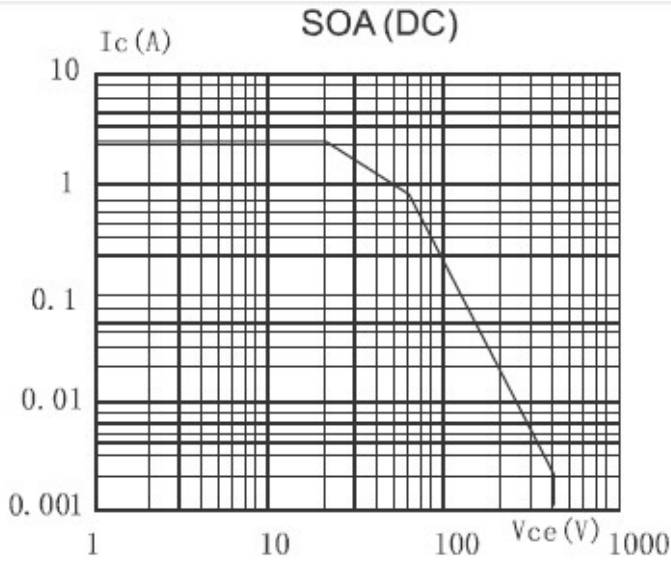

# TO-126机械尺寸图

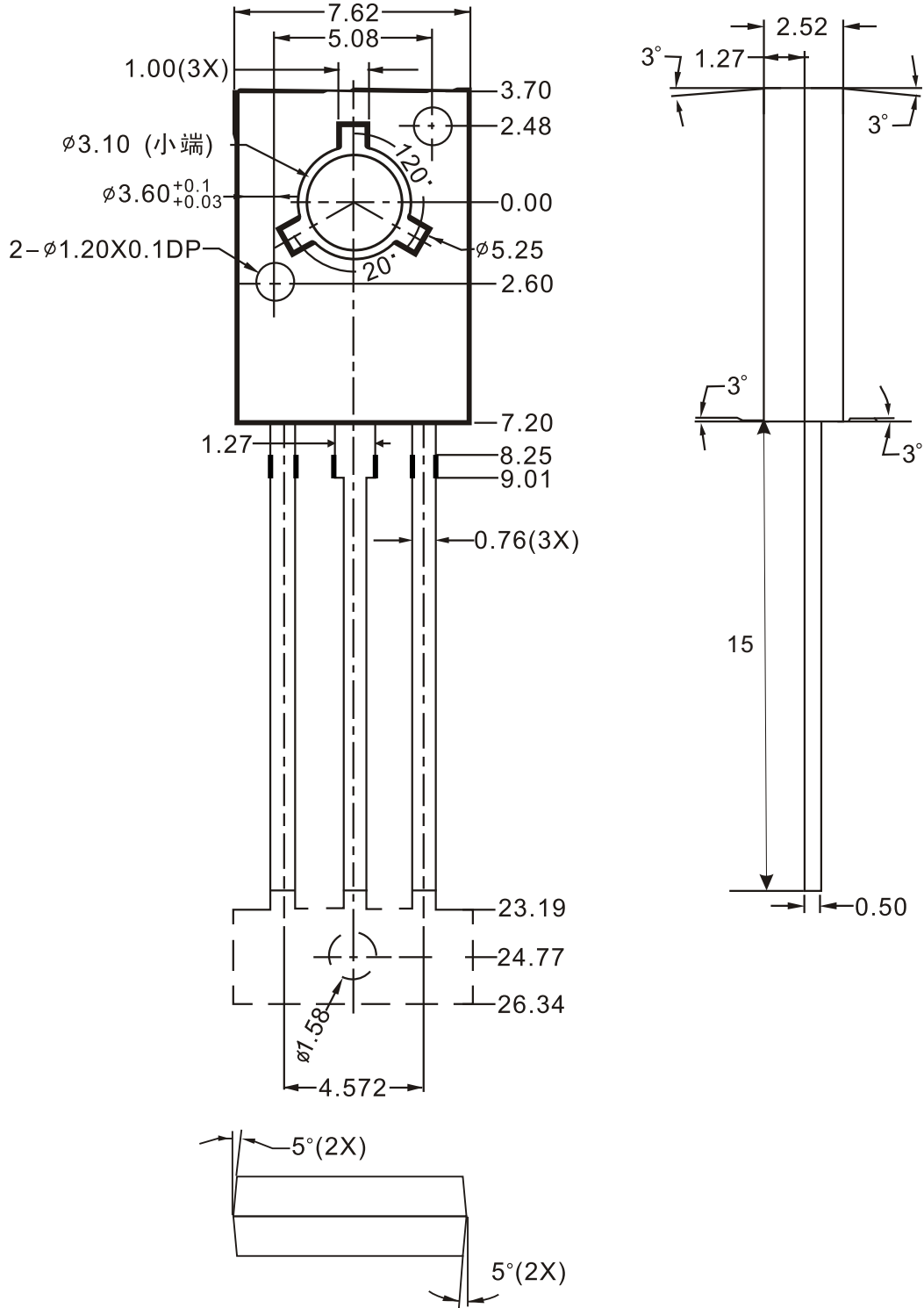

\* 注：可按客户要求增加切短脚工序